



MOTORIZED INDOOR DOME CAMERA QUICK START GUIDE

2MP/5MP/8MP IP Cameras

CAT5 / 6 / 7

CONTENTS 1

- 2 Introduction
- 3 Safety Instructions
- 4 Package Contents
- 5 Installation
- 6 Network Cable Setup
- 7 Network Connection
- 8 Resources

INTRODUCTION 2

Thank you for purchasing our product. We make every effort to update and ensure accuracy of the information contained in this manual, which may be subject to change from time to time without prior notice. For any questions or needs, please feel free to contact us at any time.

SAFETY INSTRUCTIONS 3

- 1) Please comply with the power supply specifications as required for this equipment and select the correct power supply.
- 2) In the case that equipment fails to operate properly, immediately contact the manufacturer or the nearest service center. Please do not attempt to disassemble the product or attempt to modify the product in any manner, which may void warranty.
- 3) For cleaning of the lens, be sure to use compressed air or a dedicated lens cleaner. For cleaning of the plastic shield, use a soft and dry microfiber cloth to wipe it. Do not use any detergents containing alcohol or benzene.
- 4) Do not drop any object onto the device or knock heavy objects onto the equipment.
- 5) Do not put the camera toward any strong light source (including lighting lamp or sun) which may cause over-exposure or light leakage (not due to defect of the product) and impair useful life of the camera.
- 6) Avoid use of the equipment in any environment other than as suggested in this manual.
- 7) Prevent water or any other liquid from flowing into the equipment.
- 8) For replacement of any parts, contact the distributor. Changing any parts in the device without authorization is not permitted and may void warranty.

OPERATING ENVIRONMENT

Power Supply	DC12V±10% / PoE (802.3af)
Temperature	-22°F ~ 140°F [-30°C~60°C]
Humidity	10%~95%
Altitude	-60m~3000m
Atmosphere	86kpa~106kpa

PACKAGE CONTENTS 4

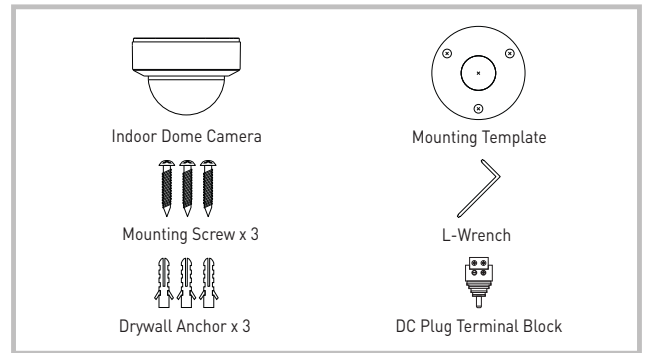

INSTALLATION 5

1. Place mounting template sticker in area where you will be mounting camera to surface that can sustain weight of camera.

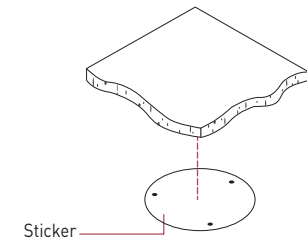

2. Remove the dome cover by rotating it clockwise, such that the lower triangle indicator moves directly underneath the upper line indicator. Then pull the dome cover off carefully.

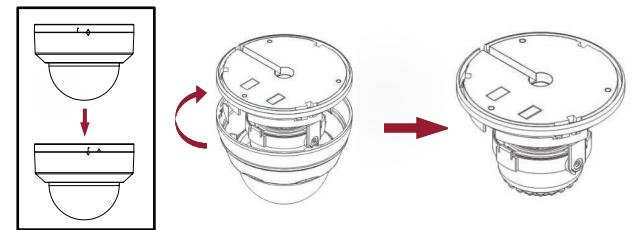

3. Drill into ceiling at marked drill holes deep enough to accommodate for mounting hardware.

- If using the included hardware, insert the three drywall anchors into holes in the mounting surface and align holes in camera mounting plate with anchors. Adjust the angle to an optimal viewing position.



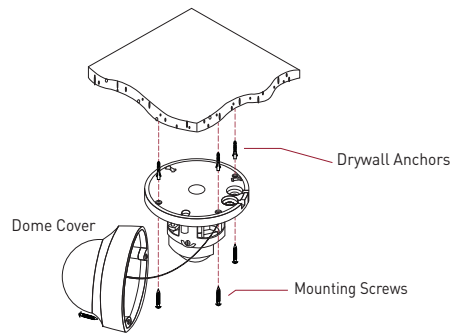

4. Fix the dome cover back onto the mounting base by installing the three dome cover screws into the camera and tightening it once the position is secured.

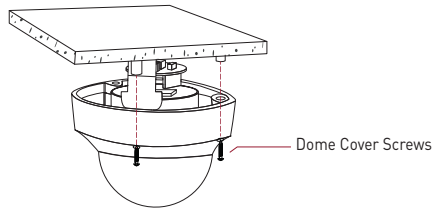

5. Ceiling Mounting complete.

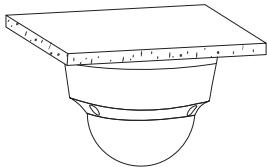

6. Bracket Adjustments

• With the dome cover removed, you can make adjustments to the pan, tilt, and rotation of the camera lens and body to allow for the best possible view for your application.

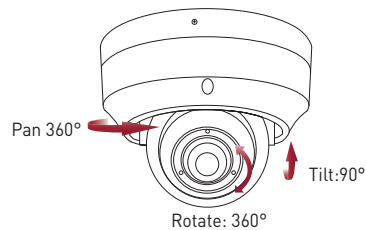

• Place the dome cover back on carefully, such that the lower triangle indicator is directly underneath the upper line indicator. Then secure the dome cover into place by rotating it counter-clockwise until the two triangle indicators are aligned.

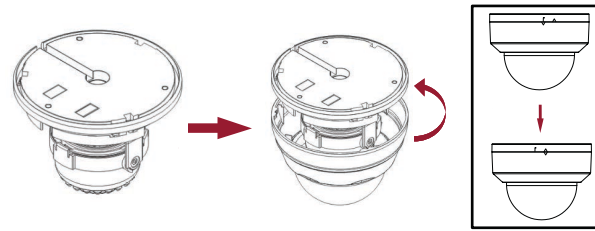

NETWORK CABLE SETUP

6

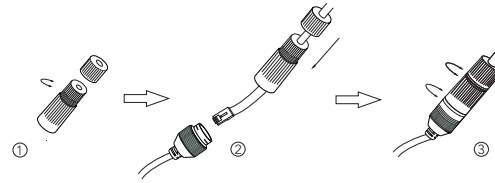

- 1 Loosen the nut from the main element.
- 2 Run the network cable (without RJ45 connector) through both elements. Then crimp the cable with the RJ45 connector.
- 3 Connect the cable to the female portion of the waterproof connector, then tighten the nut and the main cover.

CAUTION

PLEASE CONFIRM THAT VOLTAGE OF POWER SUPPLY USED MATCHES POWER REQUIRED BY CAMERA, OTHERWISE PERMANENT DAMAGE OR RISK OF FIRE MAY OCCUR

NETWORK CONNECTION

7

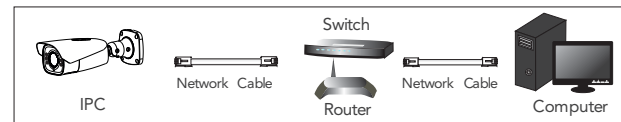

- 1 Make sure that the camera and the PC are connected to the local network.
- 2 Install the IP Device Tool from the CD and run it after installation.

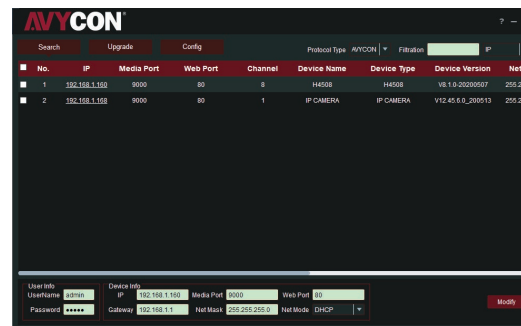

Note: DHCP is enabled by default.

- 3 Camera Activation: Click on the IP address of the camera you want to activate, which will open that camera's system in your web browser. Alternatively, if you already know the IP address of your camera, you can manually enter it into the address bar of your web browser to reach the same screen.
- 4 The first time you access the camera, you will be prompted to choose a password that must be between 8 to 15 characters. Once you are done, click on the 'OK' button to confirm your login information. The camera is now activated.

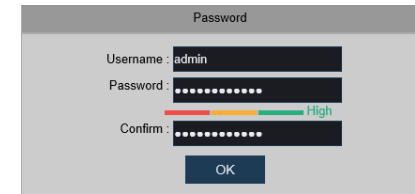

- 5 After setting up your credentials, you can access the camera by logging into the system with the password you just created.

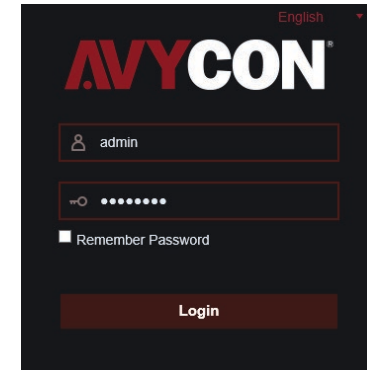

RESOURCES

Need help?

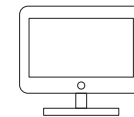

- 1) Visit www.avycon.com
- 2) Search for the model number of your product.
- 3) Click on your product and find appropriate documents on product page.

Technical Support E-mail :
 Technical Support Website :
 US Helpdesk Number :
 Toll Free Number (Canada) :

support@avycon.com
www.avycon.com
 1 (949) 752-7606
 1 (888) 833-4611
 [M-F, 6am-5pm PST]